

















33 501 662



- Ausladung 125 mm
- starrer Auslauf
- runder luftangereicherter Strahl
- Armaturenhöhe 134 mm
- Höhe bis Luftsprudler 52 mm
- Bohrungsdurchmesser 35 mm
- 2x Druckschlauch M 8 x 1 eingeschraubt, dichtheitsgeprüft
- Durchfluss max. 5,7 l/min
- bleifrei
- Dieses Produkt leistet einen Beitrag zur Erfüllung der Vorgaben von nachhaltigen Gebäudezertifizierungen, z.B. LEED®, BREEAM®, DGNB

Nur für Becken mit Überlauf geeignet.

	Bronze gebürstet	33 501 662-42
	Chrom	33 501 662-00
	Platin gebürstet	33 501 662-06
	Platin	33 501 662-08
	Dark Chrome	33 501 662-19
	Light Gold	33 501 662-26
	Light Gold gebürstet	33 501 662-27
	Messing gebürstet (23kt Gold)	33 501 662-28
	Rot	33 501 662-29
	Orange	33 501 662-30
	Dunkelgrün	33 501 662-31
	Schwarz matt	33 501 662-33
	Champagne gebürstet (22kt Gold)	33 501 662-46
	Champagne (22kt Gold)	33 501 662-47
	Chrom gebürstet	33 501 662-93
	Dark Platin gebürstet	33 501 662-99

33 501 662
mm [inches]

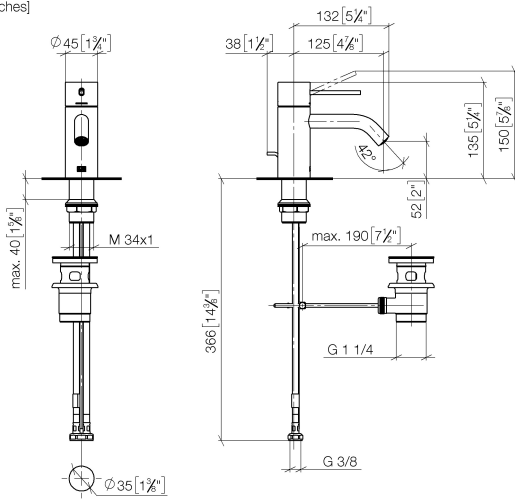

Durchflussdiagramm



META META SLIM Waschtisch-Einhandbatterie mit Ablaufgarnitur - Bronze
gebürstet

META

33 501 662

Ersatzteile für die
anderen
Oberflächenvarianten
finden Sie hier:
Chrom

